

LED Grow Light

- Commercial Grade

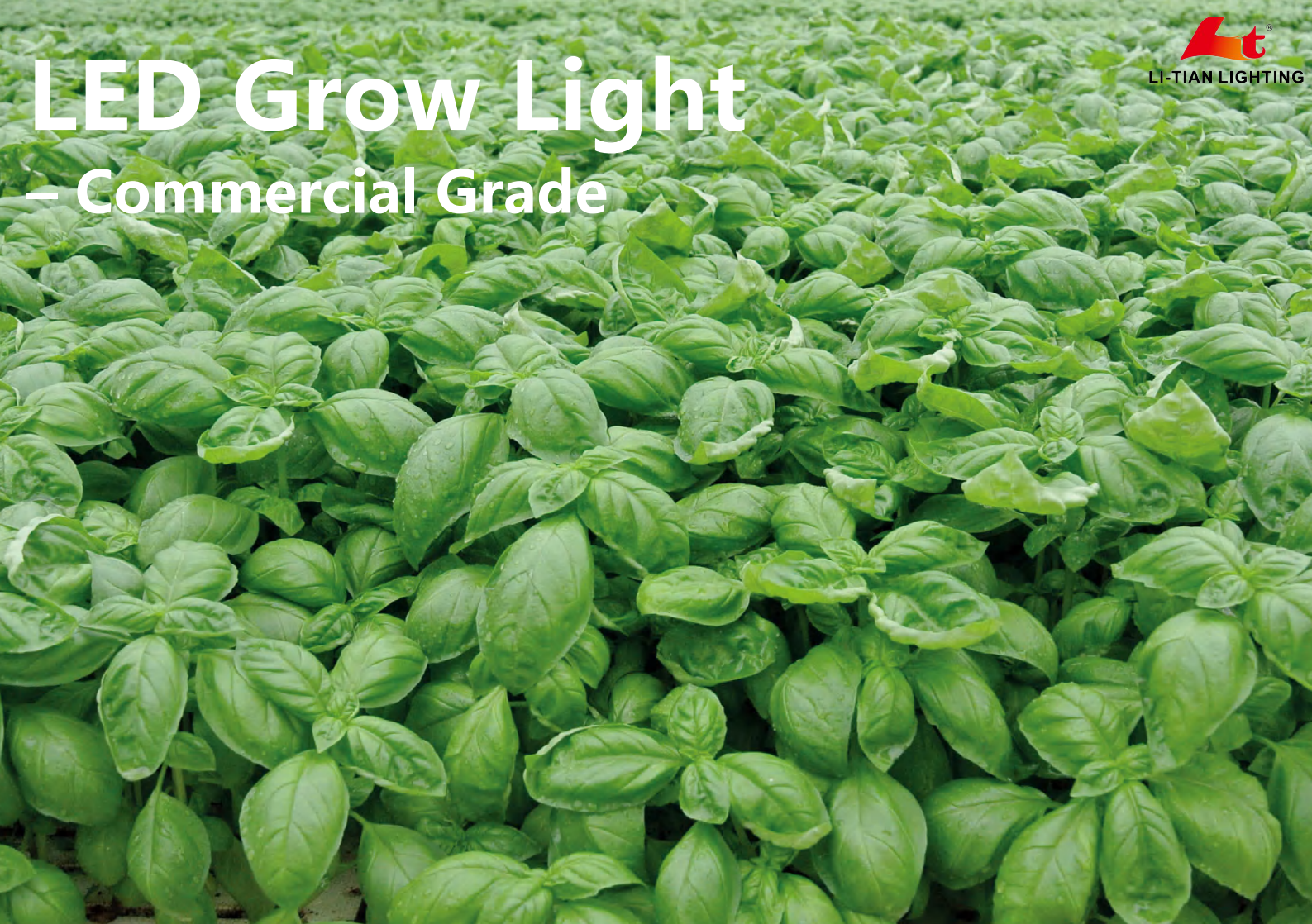

Switch from HPS to LED Grow Lights and increase your yields & profits 30 - 70+%

Without adding any additional heat, energy costs or cooling requirements.

Growcraft Yield Max Spectrum

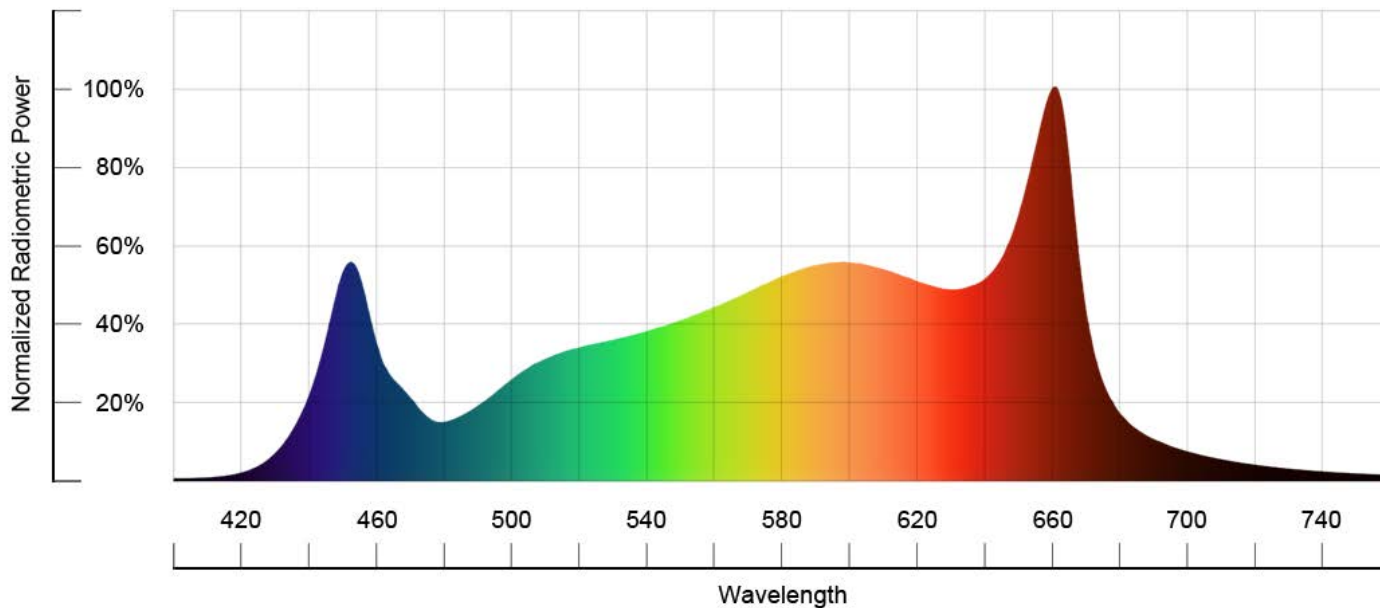

5ft x 5ft Canopy

LT-X6-1000W LED Grow Light – Commercial Grade

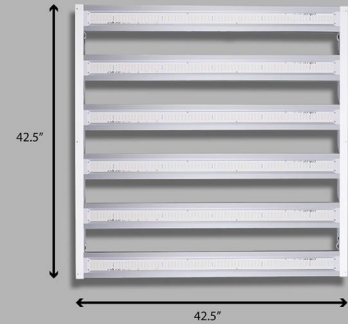

Item Included

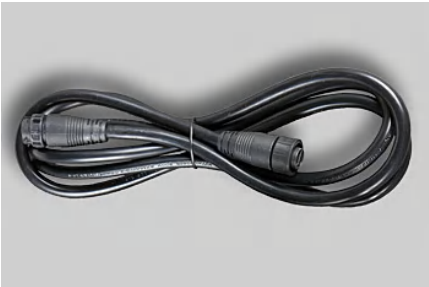

1 x Push Lock 7ft Driver Extension Cable

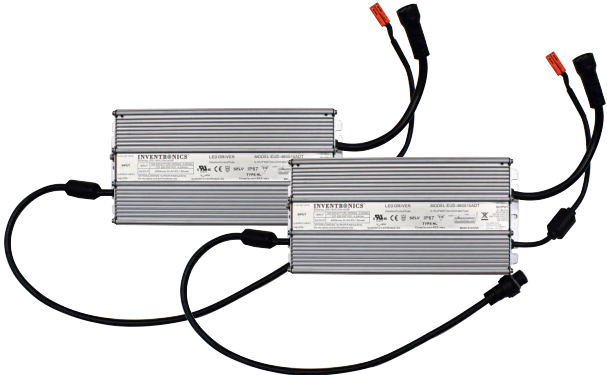

2x Push-Lock INVETR NICS EUD-480S10ADT



1 x Push Lock AC Power Cord



1 x Push-Lock Dimmer Pot

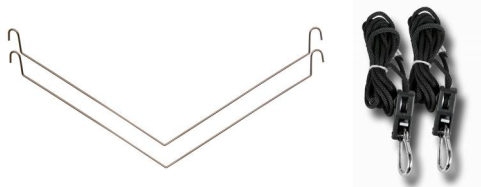

2 x 3/16in Rope Ratchet – Metal Mechanism

Specification



LI-TIAN LIGHTING

Input Power Draw	1000W
Input Voltage Range	90-305 VAC
120 VAC Current Draw	8.4 Amps
208 VAC Current Draw	4.8 Amps
240 VAC Current Draw	4.2 Amps
277 VAC Current Draw	3.6 Amps
Power Driver	2 x INVETR NICS EUD-480S10ADT
AC Power Cord Length	6.5 ft
DC Extension Cord Length	7 ft
Dimming Range	5-100%
Light Engine Efficacy	3.26 $\mu\text{mole/J}$ – 2.73 $\mu\text{mole/J}$
Power Driver Efficiency	95% @ 230 VAC
Linear Power Control	50W – 1,000W dimmable range
Full System Efficacy	3.08 $\mu\text{mole/J}$ – 2.58 $\mu\text{mole/J}$
Operating Temperature Range	41°F – 95°F 5°C – 35°C
Operating Humidity Range	10 – 90% Non-Condensing
Generated Heat Load	3,412 BTU/Hou
Fixture Dimensions	42.5 in x 42.5 in x 1.375 in
Fixture Weight	20 KG

Minimum Head Space Above Fixture: 10 in

Recommended Hanging Height: 18-30 in

Coverage Area: 5 x 5 ft

Start Slow – Growcraft lights have VERY high light output and unless your plants are already acclimated to high light intensity, it is best to start slow with the light hanging high and possibly also dimmed. Then monitor plant reaction over a few days and slowly adjust as needed.

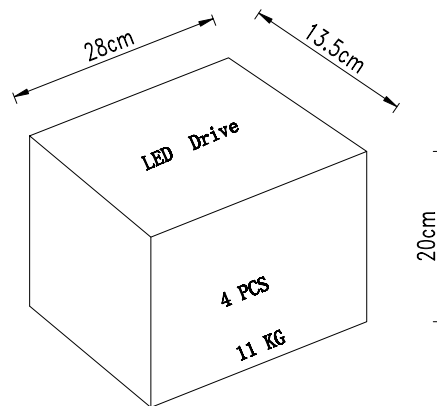
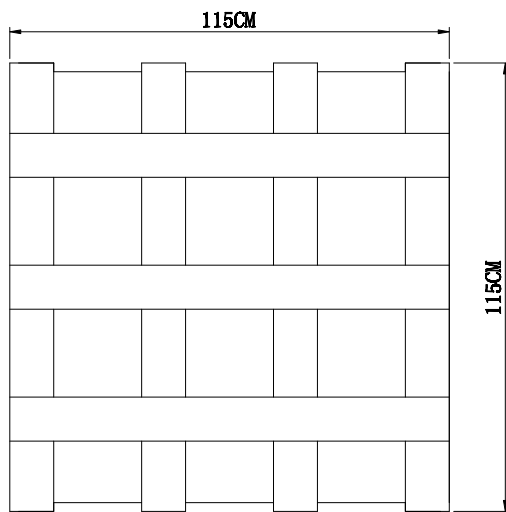
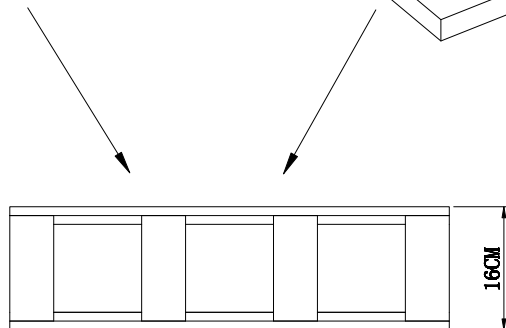
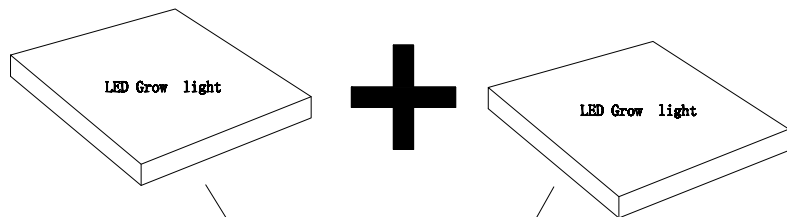

1000W 40KG

LED Grow light + LED Drive = 51KG